

GRIDCOOLER®

KEEL COOLER

Product Catalog



TABLE OF CONTENTS

PAGE 3	INTRODUCTION
PAGE 4	KEEL COOLING TECHNOLOGY
PAGE 5	ENGINEERED TO COOL
PAGE 6	MATERIALS
PAGE 7	DESIGN FLEXIBILITY
PAGE 9	STACKED GRIDCOOLER KEEL COOLER
PAGE 9	ANGLED TUBE GRIDCOOLER KEEL COOLER
PAGE 10	INSTALLATION
PAGE 11	RECOMMENDATION INFORMATION



YOUR SOLUTION IS OUR COMMITMENT

R.W. Fernstrum & Company has been engineering and manufacturing custom heat exchangers for the marine industry since 1949. Each cooling solution is engineered to meet the requirements of your engine, vessel, and operating conditions. Our commitment to quality means you get a reliable, long-lasting cooling system from Fernstrum®, the pioneer of the rectangular tube keel cooler.

The GRIDCOOLER® Keel Cooler has continually evolved to meet the performance expectations of naval architects and the marine industry worldwide. Our team of craftsmen employ the latest technologies to maximize our manufacturing process. The result is a custom-designed GRIDCOOLER Keel Cooler solution that performs as expected, meeting your exact needs.

Fernstrum set the standard in marine heat exchangers over 65 years ago, building a reputation focused on innovation. Today, we continue our commitment to constant improvement, ensuring you have quality, reliability, and the latest in cooling technology on your side.

Contact our sales and engineering team for expert advice on cooler sizing, placement, installation, and service. We're excited to welcome you to the ever-growing Fernstrum family.

Keel Cooling Technology

A keel cooler is a closed circuit cooling system mounted externally on the vessel's hull below the waterline. The concept of keel cooling is similar to the application of a radiator on a car. Engine coolant is circulated through the keel cooler, which transfers heat from the coolant before it returns to the engine. The keel cooler is in constant contact with seawater allowing the cooling system to efficiently transfer heat between the coolant and seawater (please see Figure I for an illustration).

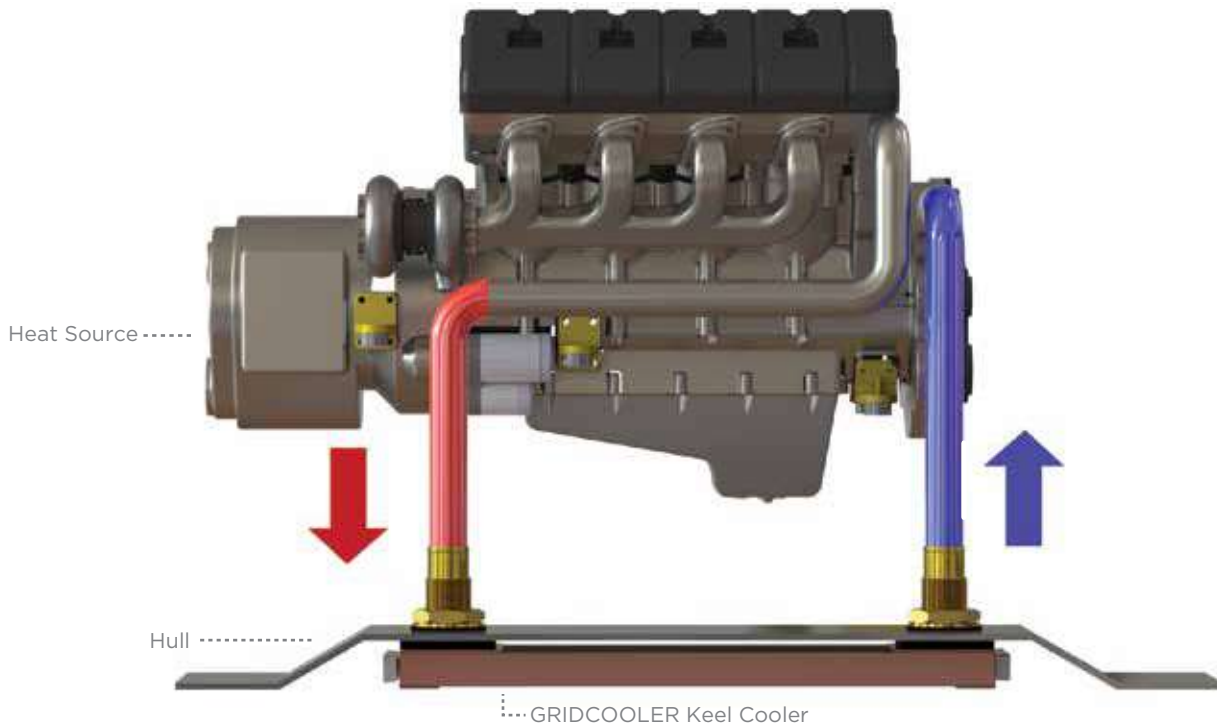

FIGURE I: *How Keel Cooling Works*

The GRIDCOOLER® Keel Cooler is mounted externally on the hull below the waterline. The engine coolant is circulated through the GRIDCOOLER Keel Cooler, which transfers heat from the coolant before it returns to the engine. The keel cooler is in constant contact with seawater to efficiently transfer heat.

Advantages

Compared to an open circuit cooling system (inboard heat exchanger), a closed circuit cooling system provides several distinct advantages. A closed circuit cooling system eliminates the need for an inboard heat exchanger, raw water pumps, strainers, seawater piping, and the high maintenance associated with open circuit cooling systems. It also eliminates silt and sand buildup in the cooling circuit and protects the system from salt water corrosion. The use of a keel cooler eliminates the need for seawater to enter the hull. From an environmentally friendly perspective, keel cooling provides a zero discharge solution eliminating the possibility of contaminants entering the seawater.

Keel Cooling Helps Eliminate

- High Maintenance
- Raw Water Pumps
- Sand & Silt Buildup
- Seacock
- Seawater Circuit
- Seawater Piping
- Strainers

ENGINEERED TO COOL

The GRIDCOOLER® Keel Cooler is a custom made cooling system engineered to meet the specific demands of the engine manufacturer and operating conditions of your vessel. With over 65 years of experience in keel cooling, our sales and engineering team can help provide a reliable cooling solution to meet your specific needs.

Heat Source

- Air Conditioning Units
- Bow Thrusters
- Compressors
- Electrical Equipment
- Generator Sets
- Hydraulics
- Land Based Applications
- Propulsion & Auxiliary Engines
- Pumps
- Reduction Gears
- Winches

Marine Applications

- ATB
- Barges
- Commercial Fishing
- Dredges
- Ferries
- Landing Craft
- Life Boats
- OSV
- Passenger Vessels
- Patrol Boats
- Pilot Boats
- PSV
- Push Boats
- Recreational Boats
- Semi-Submersibles (ATV & ROV)
- Tug Boats



Stationary & Industrial Applications

- Buoys
- Drainage Systems
- Facilities' Climate Control
- Hydroelectric Plants
- Irrigation Systems
- Lift Stations
- Offshore Wind Generators
- Pump Station Engines
- Storm Sewer Systems
- Wave & Tidal Generators

The application lists provided are only partial lists. If you have an application outside of these parameters, our sales and engineering team may be able to help provide a solution. Please call 906.863.5553 or email sales@fernstrum.com.

The GRIDCOOLER® Keel Cooler is a completely assembled unit and is factory tested to ensure dependability. The rectangular shaped tubing used in its construction is structurally sound and provides a higher heat transfer rate than round tubing.

Fernstrum provides premium materials to help maximize your cooling system:

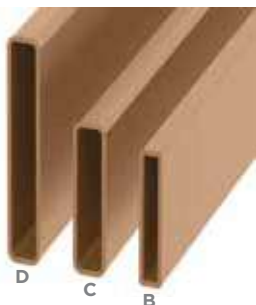

Available in 3 sizes

90/10 Copper-Nickel

The copper-nickel GRIDCOOLER Keel Cooler is crafted using heavy walled rectangular 90/10 copper-nickel tubing. This alloy was selected based on its durability, heat exchange abilities, resistance to salt water corrosion, and natural antifouling capabilities.



Smooth Surface



Enhanced Surface

Enhanced & Smooth Interior Walled Tubing

Fernstrum® offers two types of surfaces on the interior of the copper nickel tubing, smooth or enhanced. The enhanced surface, a Fernstrum exclusive, is a truncated cone pattern on the interior of the tube generating greater heat transfer. Compared to a smooth walled tube, the enhanced tube increases the heat transfer capability by up to 30 percent. This is especially true in applications where glycol solutions are utilized. The improvement in efficiency may reduce the number or size of the units required for an application.

Note: The interior surface of the tubing is determined based on your cooling requirements.



Brazing

Silver Braze Wire

Each copper-nickel keel cooler is torch brazed with 56% silver (content) braze wire to maximize the flexibility and durability of the unit. The higher silver content offers superior corrosion resistance, improving the dependability of the keel cooler and its ability to withstand harsher operating conditions. Critical braze joints are ultrasonically tested as an added measure to ensure the unit's reliability.



Aluminum
GRIDCOOLER Keel Cooler

5000 Series Aluminum

The aluminum GRIDCOOLER Keel Cooler is designed specifically for unpainted aluminum hull applications in fresh or cold seawater environments. 5000 series aluminum alloy was selected based on its compatibility with unpainted aluminum hulls and saltwater corrosion resistance. The alloy compatibility between the hull and keel cooler prevents pitting and avoids potential damage from interacting metals. Aluminum units are tig welded for durability.

DESIGN FLEXIBILITY

The GRIDCOOLER® Keel Cooler is sized to meet your engine's cooling requirements and operating environment. Our team will work with you to recommend features to optimize the functionality of your cooling system. The following examples show a few of the more common configurations. Additional configurations are available upon request.

One Piece Header Design

Fernstrum® has continually evolved the GRIDCOOLER Keel Cooler's design to improve efficiency and dependability. The rectangular one piece header design has fewer joints for improved durability and provides greater flexibility in custom cooling solutions.

Single- & Multi-Pass Designs

Fernstrum offers a range of single- and multi-pass designs to help optimize your cooling solution. These designs maximize the efficiency of the engine coolant flow, allowing for a more compact solution.

Standard Through-Hull
Single-Pass Design

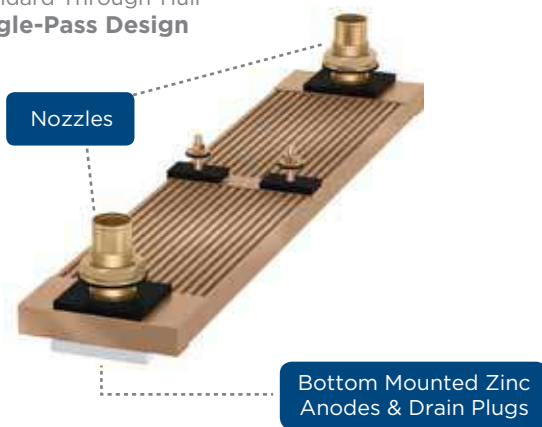

Standard Through-Hull
Multi-Pass Design

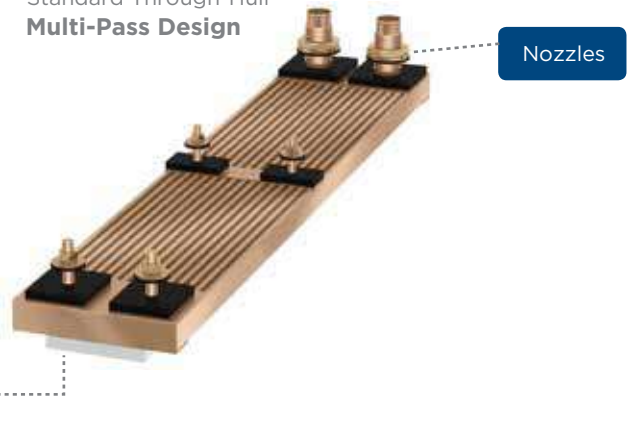

ILLUSTRATION: Single- & Multi-Pass Designs

Nozzles on a single-pass design are located on opposite ends of the keel cooler; whereas, the nozzles on a multi-pass design are located on the same end of the unit.

E1 SERIES units place the zinc anodes and drain plugs on the end of the keel cooler reducing the hull projection; a benefit to high-speed craft and fishermen where entanglement of nets and/or lines is a concern.



HD SERIES stiffener plates can be added to units providing additional support to prevent tubes from bowing, bending, or vibrating from the impact of heavy seas. These plates do not have additional mounting points. The HD Series is ideally suited for applications where the vessel is operating in heavy pounding seas, strong currents, or the keel cooler is positioned near the bow of the vessel.

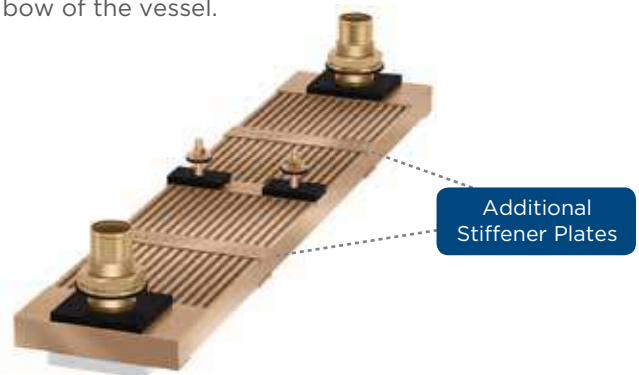

DESIGN FLEXIBILITY

L SERIES support plates are designed to minimize intermediate support bolt hull penetrations. These support plates extend beyond the keel cooler side tubes, providing additional securing options. This feature is especially useful in retrofitting a keel cooler to an existing vessel.

Single-Pass L SERIES

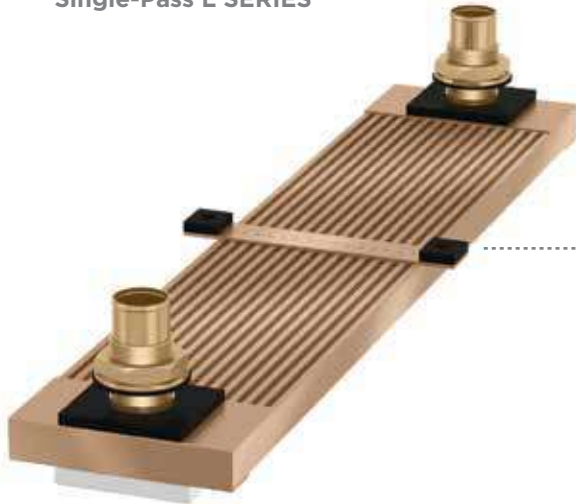

Multi-Pass L SERIES



Z SERIES flanges relocate the connecting and mating points to the hull's exterior, eliminating hull penetrations. The typical through-hull nozzle mounting connections are replaced with a flange. Mating flanges are provided in carbon or stainless steel. Additional mounting hardware is also supplied for isolation. This design is ideal for installations where mounting hardware cannot be easily accessed from the interior of the hull, easing installation on double hulled vessels and may eliminate the need for cofferdams. L Series support plates are standard in this configuration.

Single-Pass Z SERIES



Multi-Pass Z SERIES



Stacked GRIDCOOLER Keel Cooler

When faced with limited space or larger cooling requirements, a stacked GRIDCOOLER® Keel Cooler reduces the footprint of the keel cooler while providing greater heat transfer. The design is ideal for cooling larger engines, reducing the number of units required, or fitting into an existing application in the case of repowering.

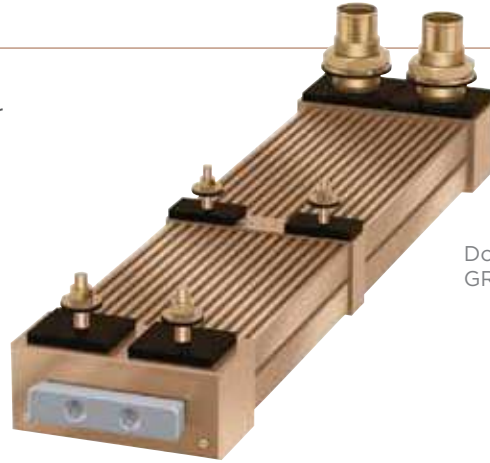

Double Stacked GRIDCOOLER Keel Cooler

Angled Tube GRIDCOOLER Keel Cooler

An angled tube GRIDCOOLER Keel Cooler optimizes the heat transfer for side mounted zero knot or stationary applications. The design exploits the natural convection current created by the heat exchanger. The unique position and angle of the tubes are crafted to maximize the flow of raw water between the tubes. This configuration also resists the collection of silt and other debris from building up on the unit.

Angled Tube GRIDCOOLER Keel Cooler



ILLUSTRATION: Angled Tube GRIDCOOLER Keel Cooler

The angled tube GRIDCOOLER Keel Cooler's tubes are positioned to enhance and exploit the natural convection current generated by the heat exchanger.

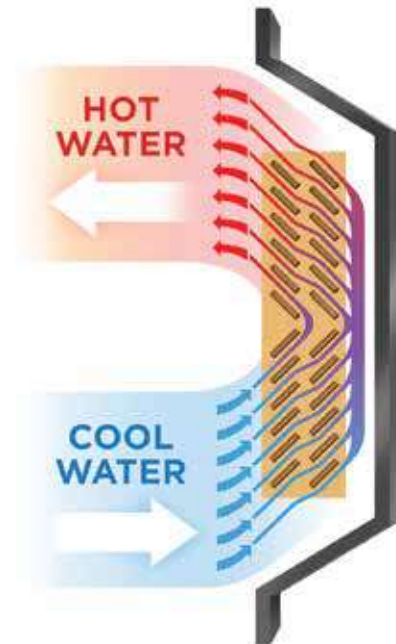

Additional Customization Options

- Bending and/or Twisting of Unit
- Extended Nozzle(s)
- Mounting Foot Pad(s)
- Side Venting
- Support Plates Available on the Top or Bottom of the Unit
- Vented Stud(s)

*Additional designs are available upon request.

INSTALLATION

Our expert engineers and sales team will help you determine the best installation solution. Please note the operating conditions and hull design of a vessel weigh heavily on how a unit is installed. Shown below are a few common installations for a GRIDCOOLER® Keel Cooler.

Recessed

Recessing a GRIDCOOLER Keel Cooler streamlines the installation and provides significant protection from potential damage. Independent tests conducted at the Vienna Model Test Basin have shown that drag is negligible when the unit is recessed into a ship's hull. The position of the recess can be located on the side or bottom of the hull. This type of installation is common in new projects and ideal for fast-moving vessels.



Recessed



Recessed

External

An external installation typically applies fairing and side plates for added protection and to improve streamlining. This mounting option is commonly used in retro-fitting projects.



External Mount



Preformed

Side Mounted

Mounting the GRIDCOOLER Keel Cooler on the side of the hull prevents potential damage to the unit. It is ideal for situations where a keel cooler cannot be mounted to the bottom of the hull.

Note: When recessing the unit into the side of the hull for generator sets and/or equipment operating at dockside, angle the top of the recess box to allow convection current over the cooler.



Side Mount - Propulsion



Side Mount - Propulsion

RECOMMENDATION INFORMATION

Our team will need the following specifications to make a proper product recommendation. Please visit our website at fernstrum.com to fill out or download a recommendation form.

Engine Information

- Engine Type (Propulsion, Bow Thruster, Generator, Other)
- Emissions Data (Tier 1, 2, 3, or IMO)
- Engine Manufacturer
- Model
- Rating (BHP / RPM, BKW / RPM, EKW / RPM)
- Engine Age
- Percentage of Antifreeze Used
- Heat Rejection
- Fresh Water Flow Rate
- Fresh Water Temp Into Cooler
- Fresh Water Temp Out or Drop Across Cooler

Reduction Gear Information

- Make & Model of Gear

Vessel Information

- Type of Vessel (e.g., Ferry, Trawler, Pleasure Boat)
- Hull Construction (Steel, Fiberglass, Wood, Aluminum Painted/Unpainted)
- Minimum Hull Speed at Full Rated Power (Under Full Load)
- Cofferdam Installation

Environmental Conditions

- Maximum Sea Water Temp



FERNSTRUM®

R.W. Fernstrum & Company

fernstrum.com

Phone: 906.863.5553 • Fax: 906.863.5203 • Email: sales@fernstrum.com
P.O. Box 97 • 1716 11th Avenue • Menominee, Michigan 49858 • USA

© 2013 R.W. Fernstrum & Company. All rights reserved.
FERNSTRUM® and GRIDCOOLER® are registered trademarks of R.W. Fernstrum & Company.